

## Guía de instalación



**Gracias** por su compra!



# iShop Homekit

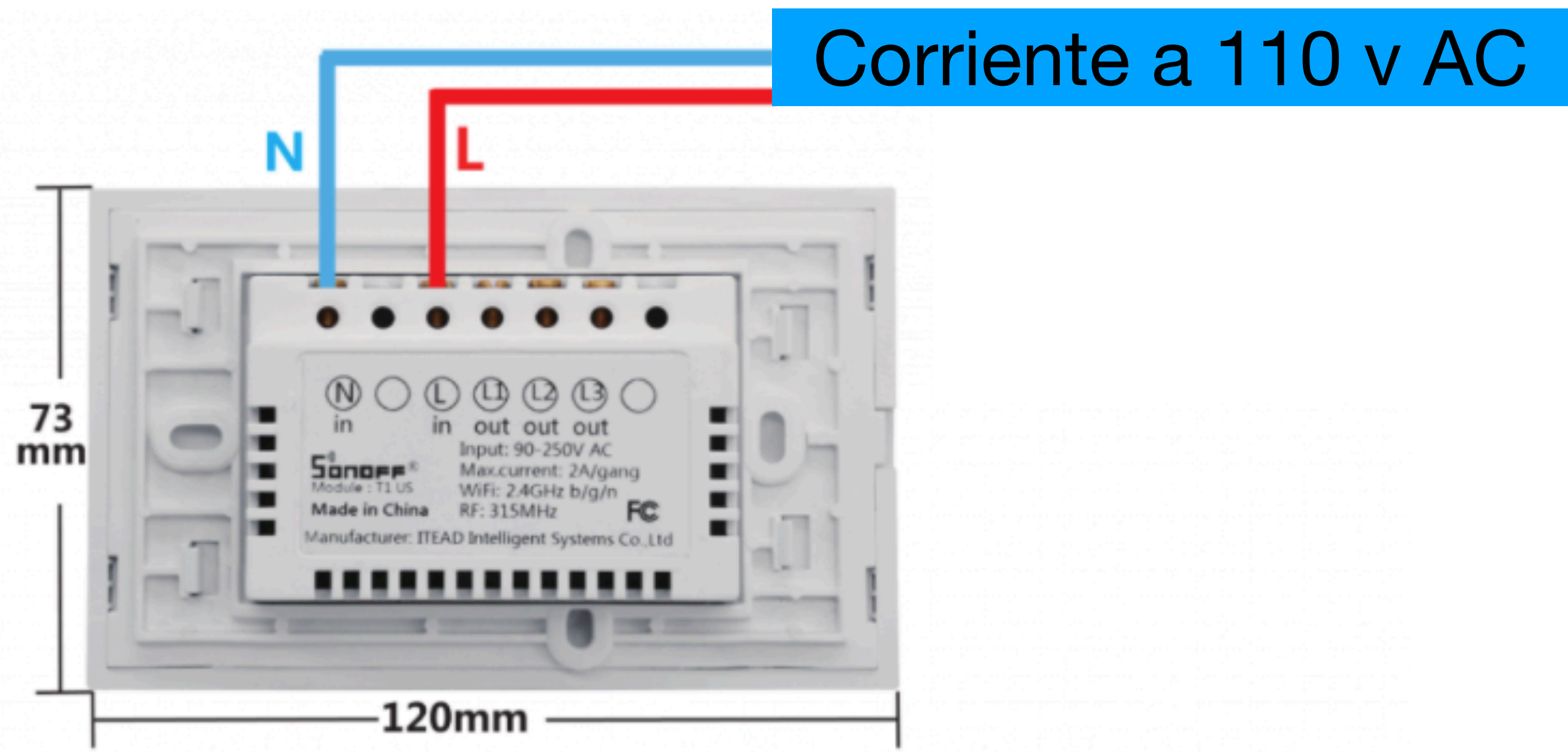

Conecta los cables en cada una de las entradas N y L

Los apagadores que van al foco en su entrada correspondiente de L1,L2 o L3

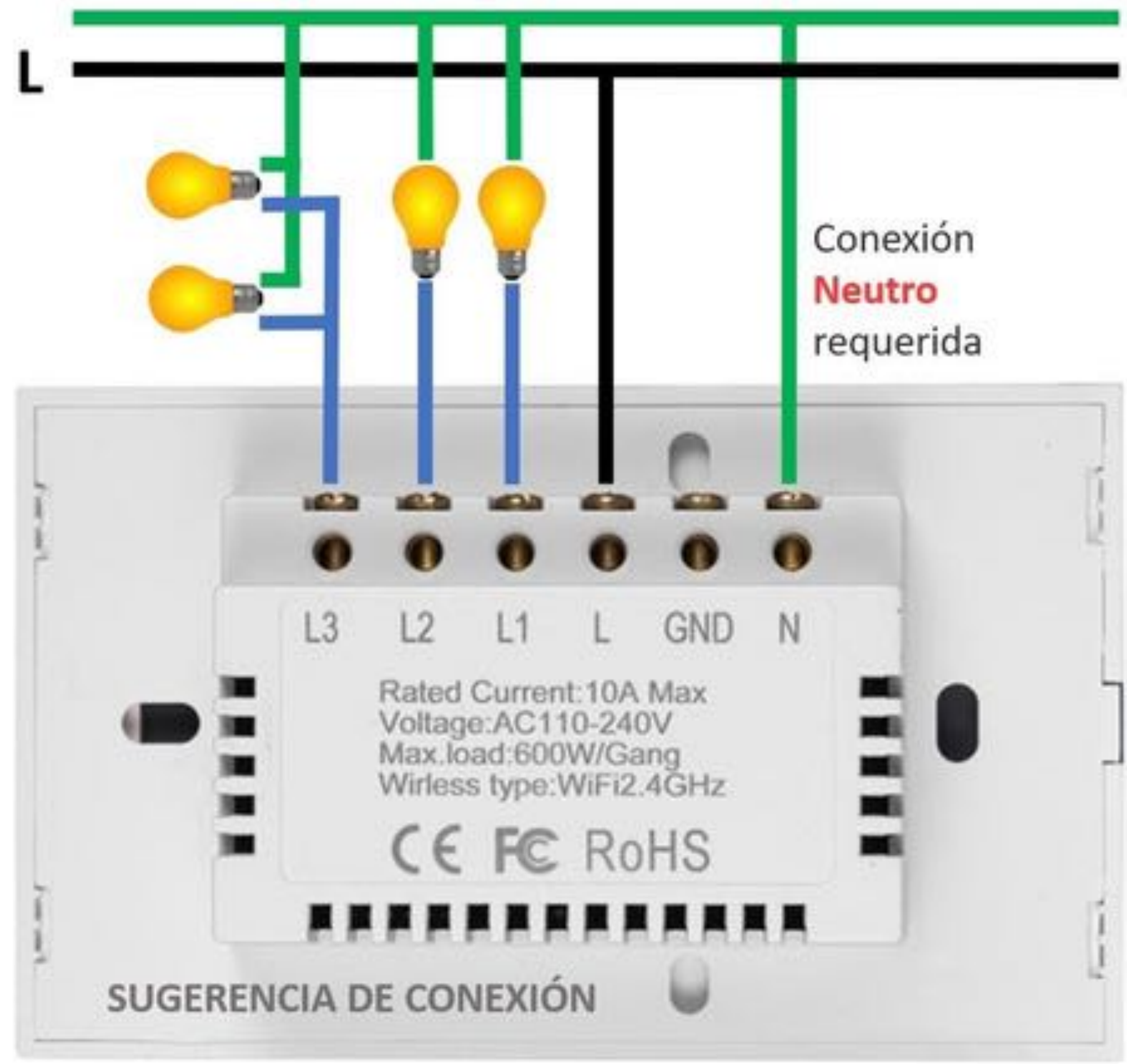

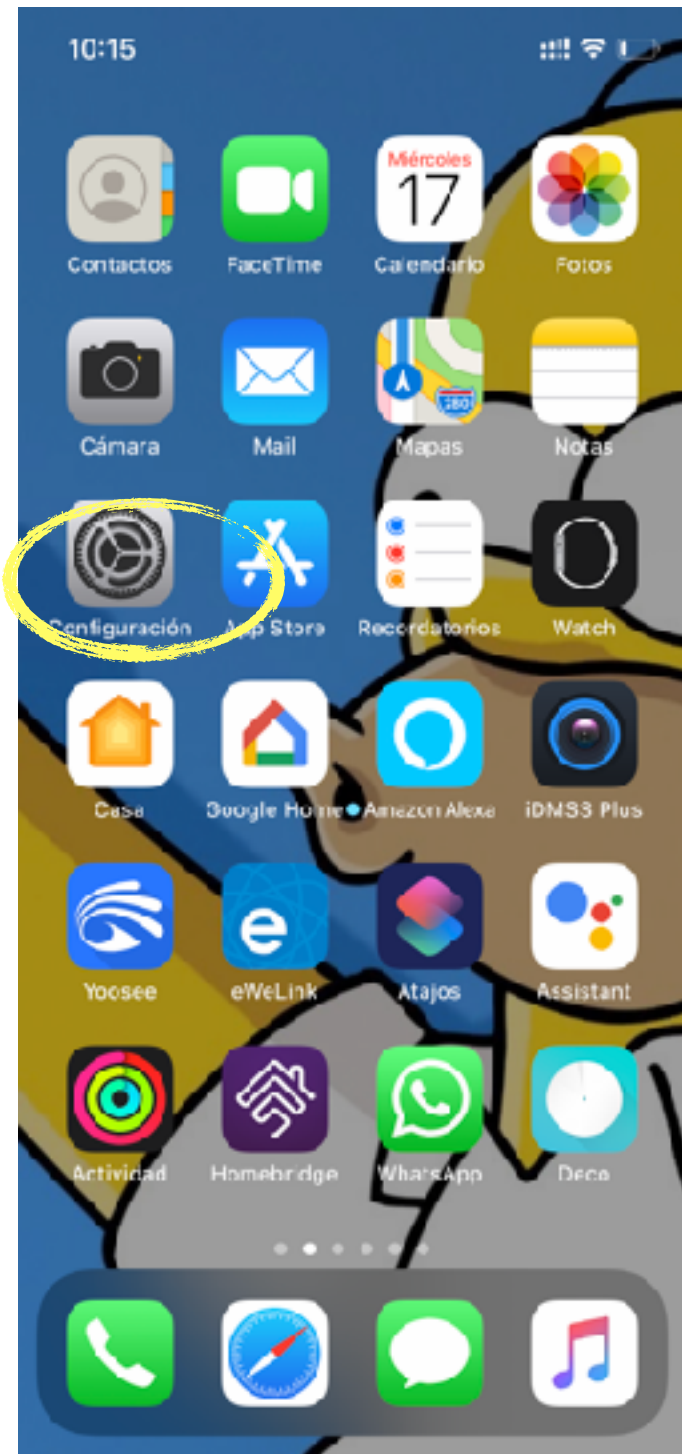

Selecciona "Configuración"

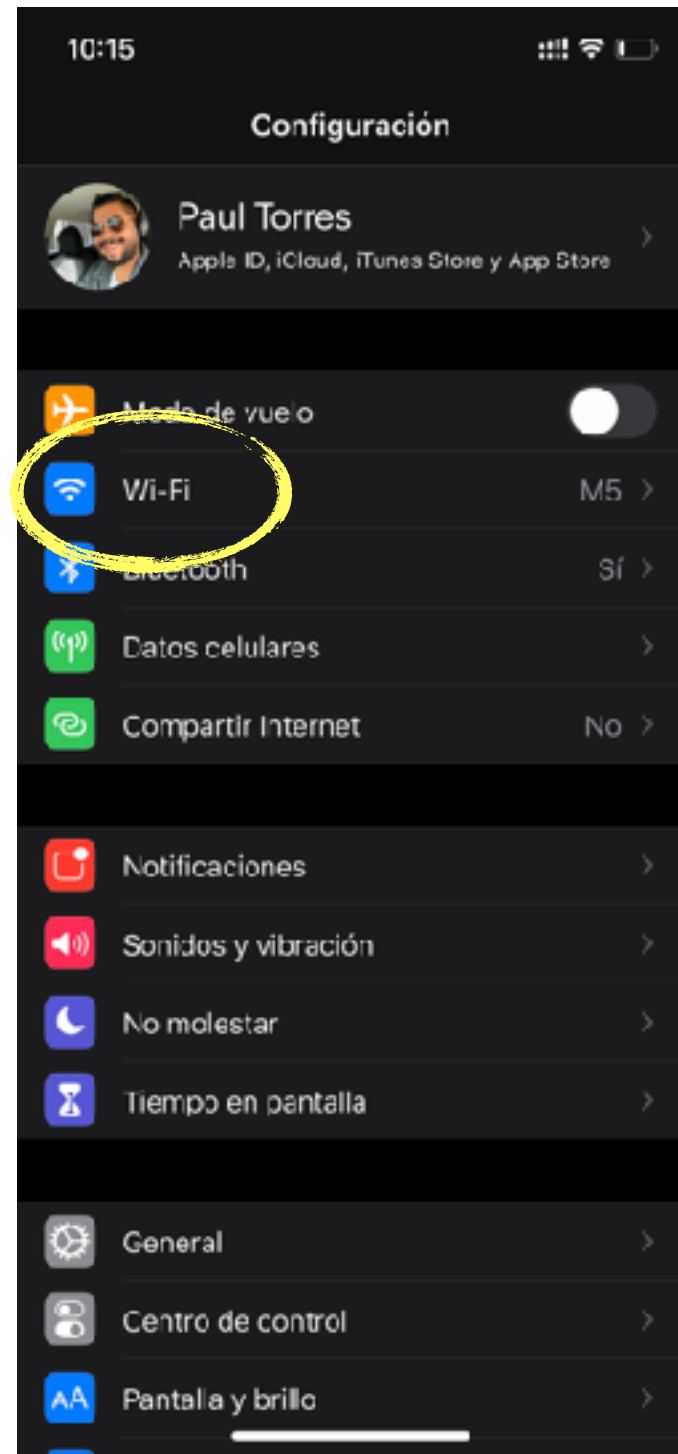

Selecciona "WI-Fi"



Seleccionaras la red Sonoff-#####

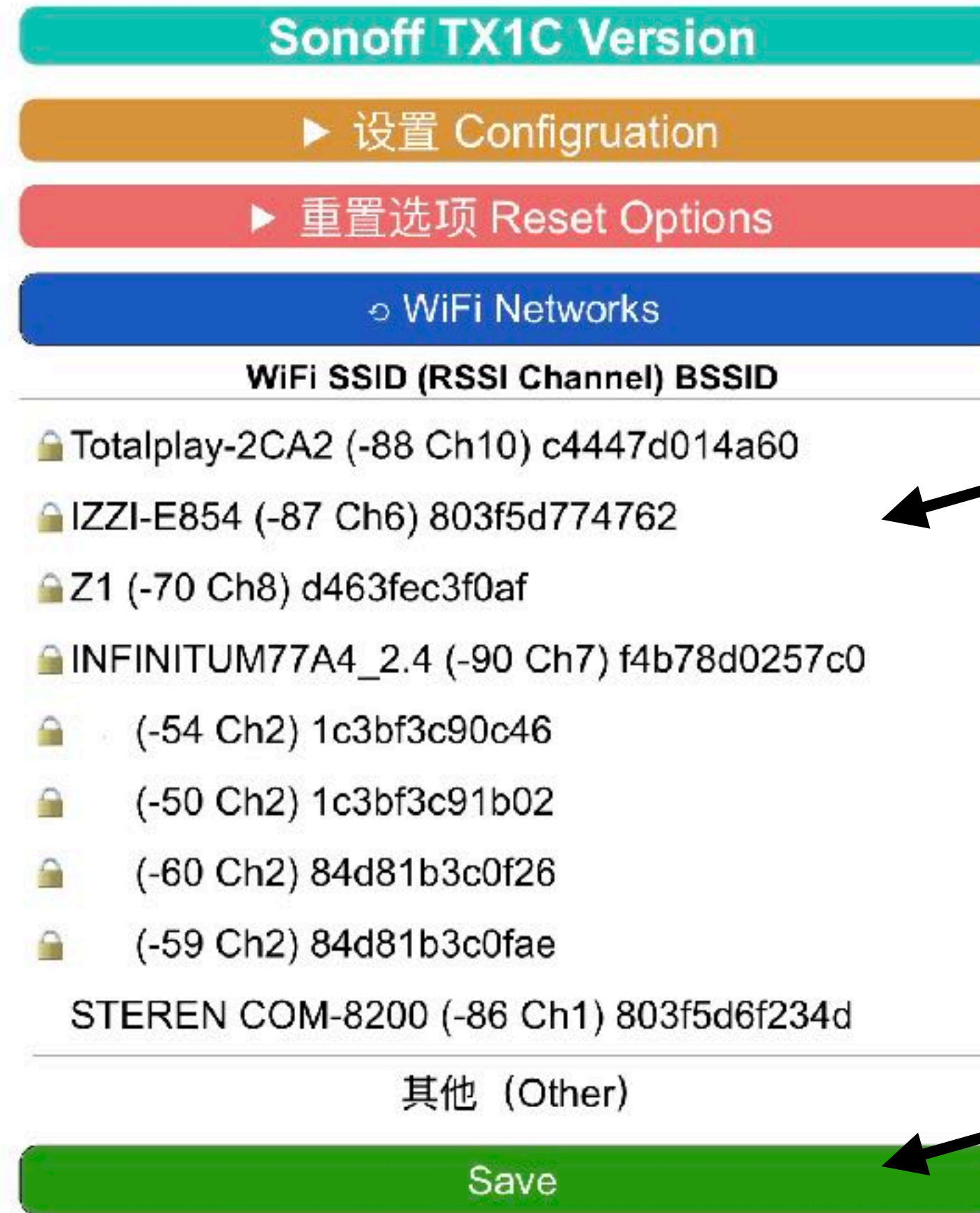

Selecciona tu red wifi  
Ingresa el pass de tu wifi

Guarda

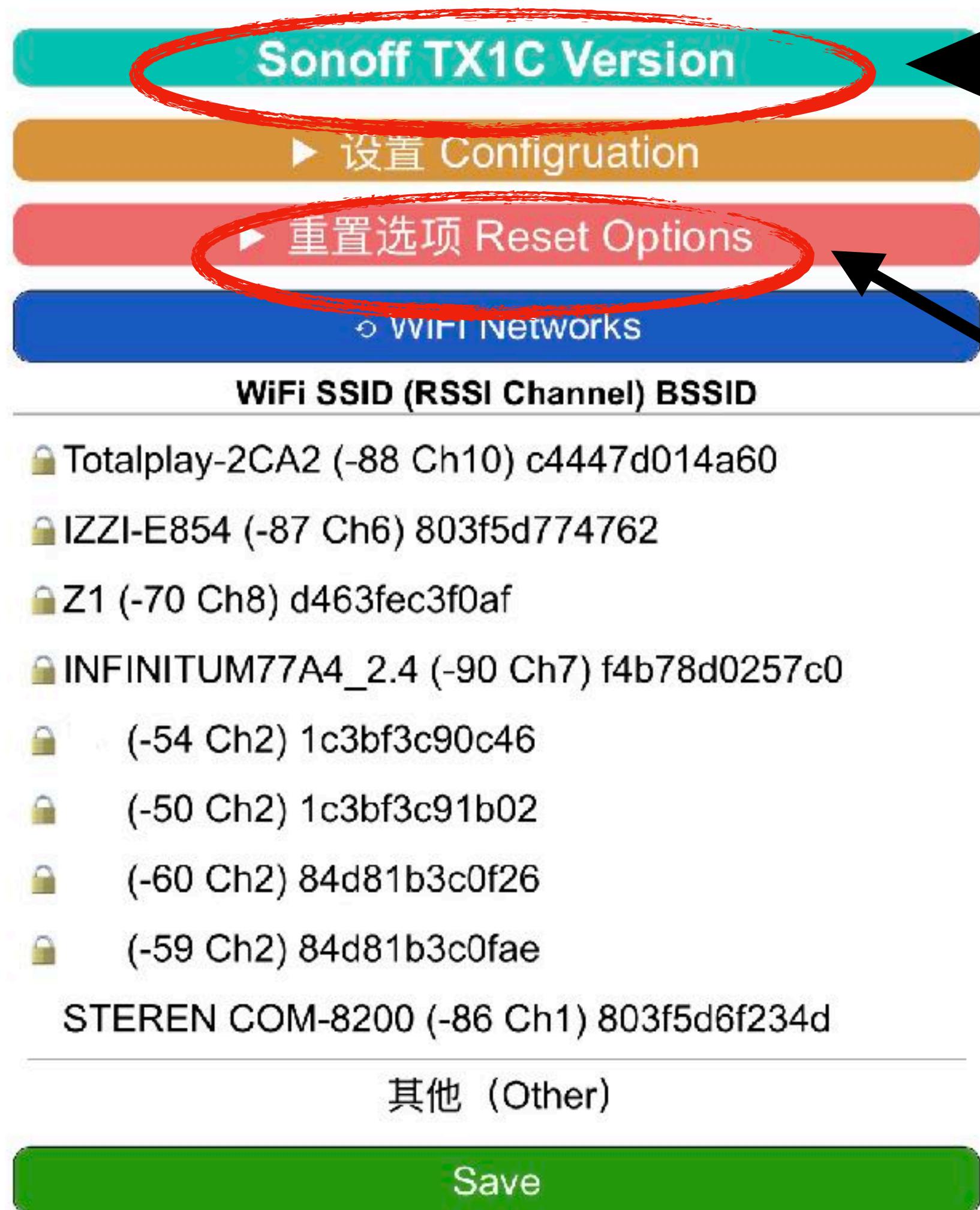
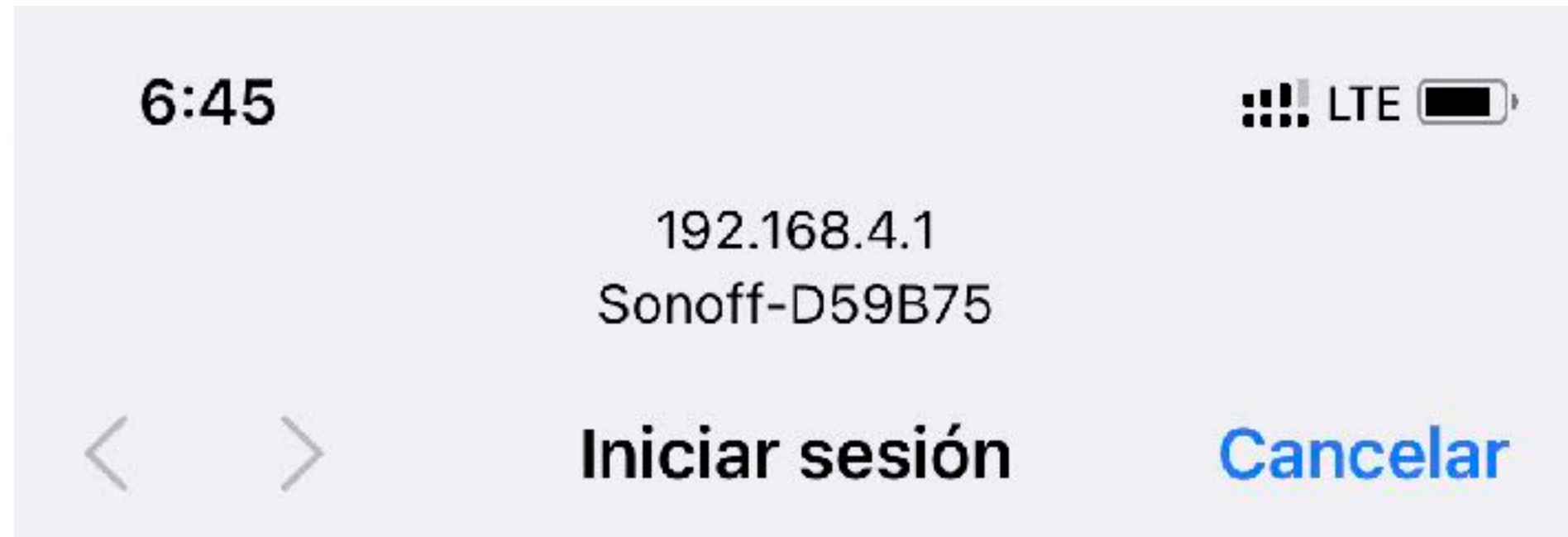

Verifica el modelo de tu Dispositivo

Opción de restablecimiento de dispositivo  
Marca las casillas de:  
Reset homekit  
Reset Wifi settings

**NOTA:**  
Esperar entre 3 y 5 minutos en lo que se construye el accesorio

# Una vez terminado los pasos anteriores

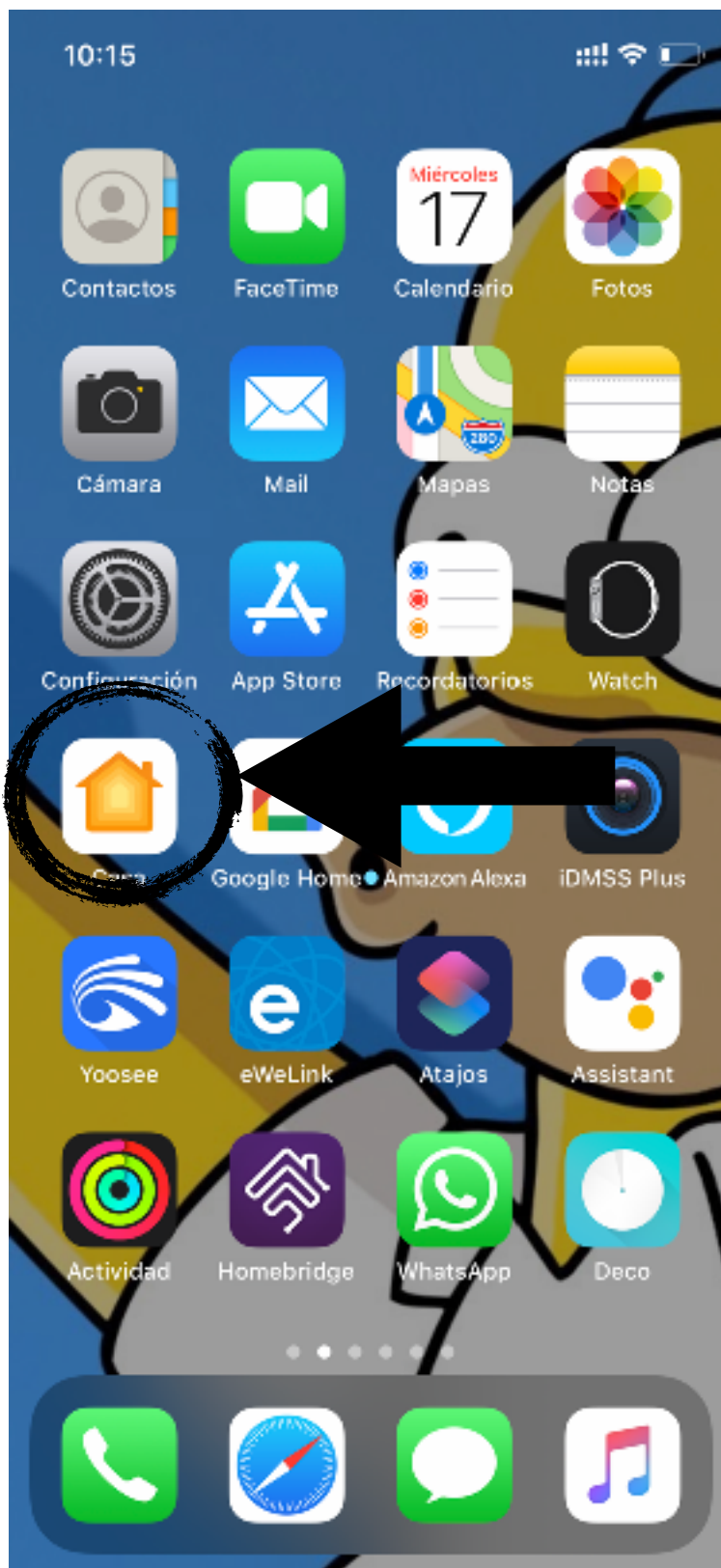

Seleccionas la app "Home"

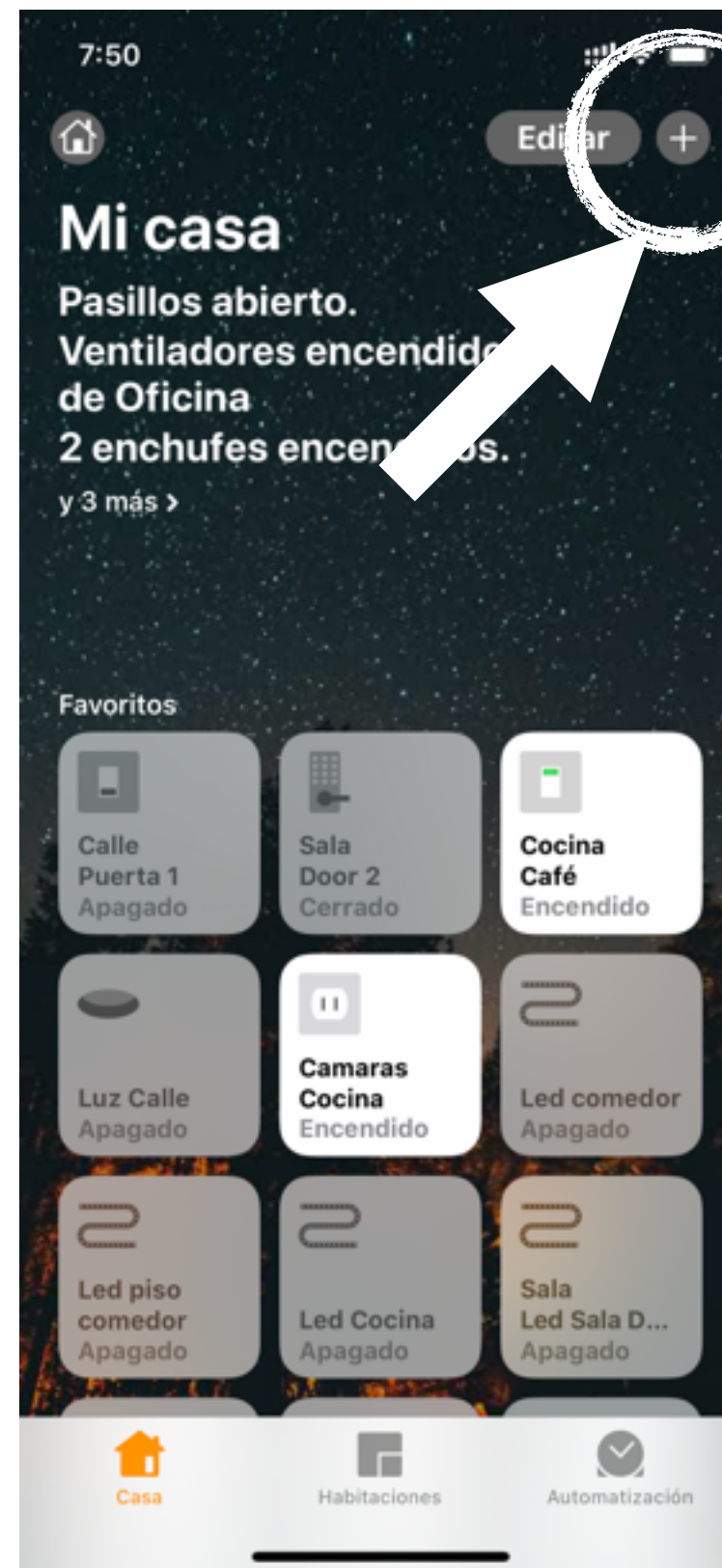

Selecciona "+"

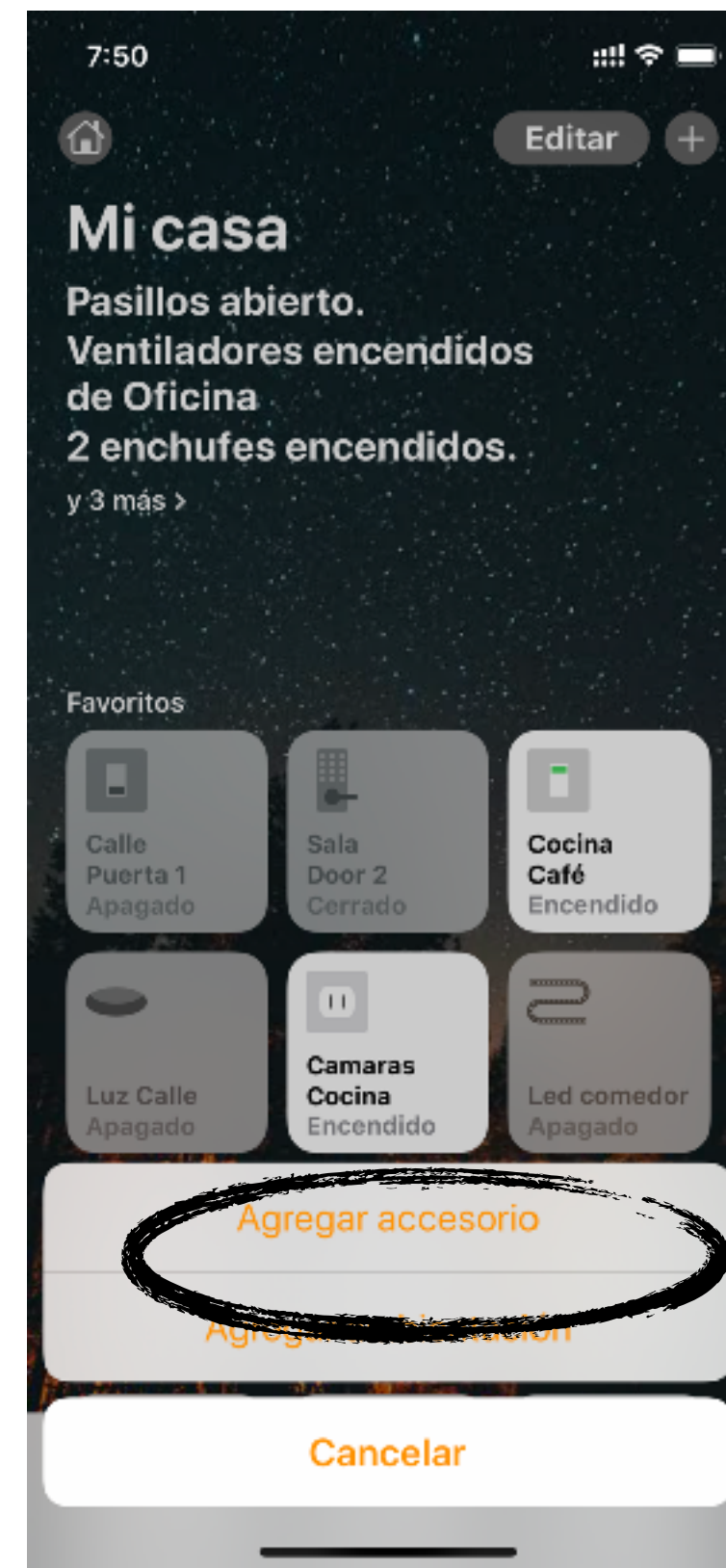

Selecciona "Agregar accesorio"

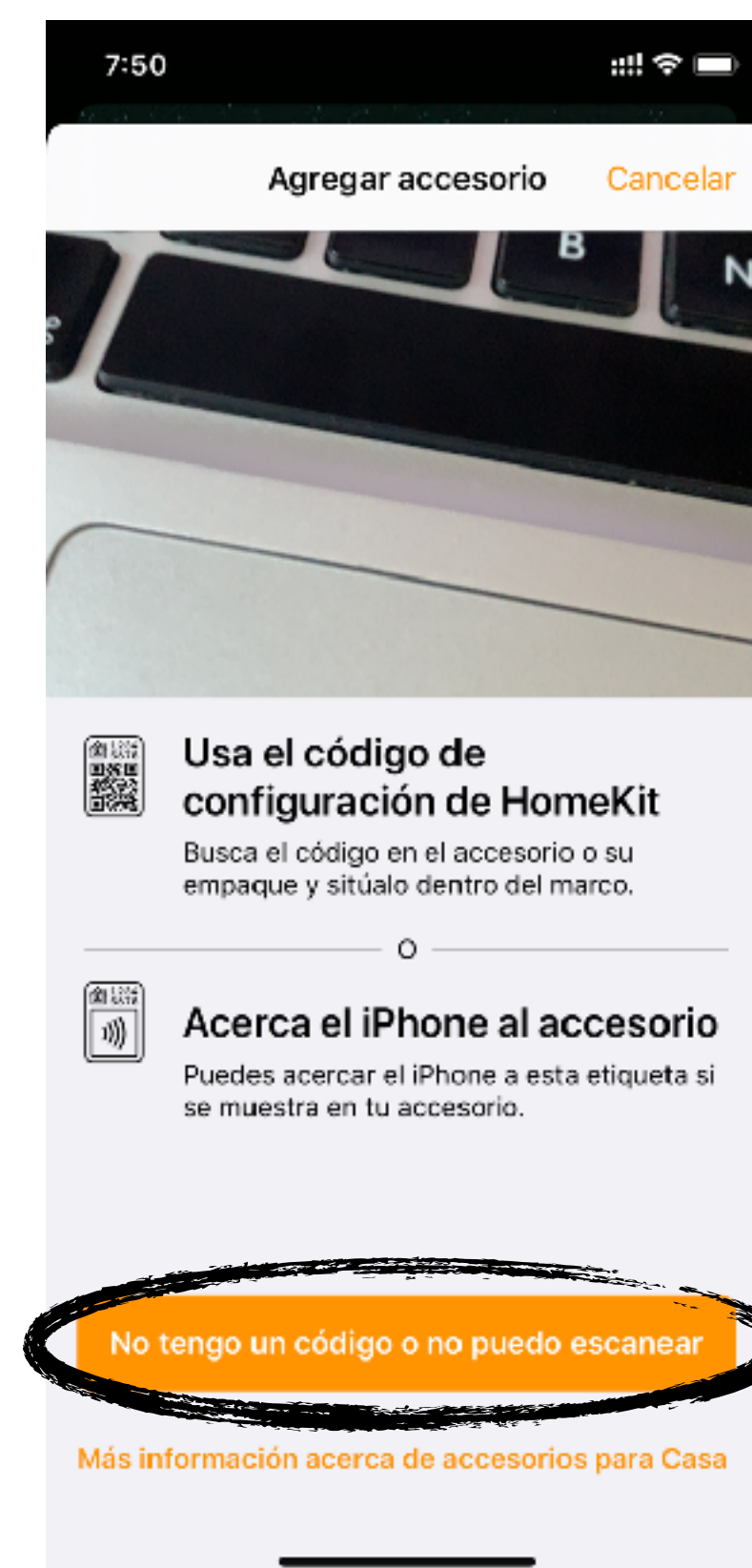

Selecciona "No tengo un código o no puedo escanear"

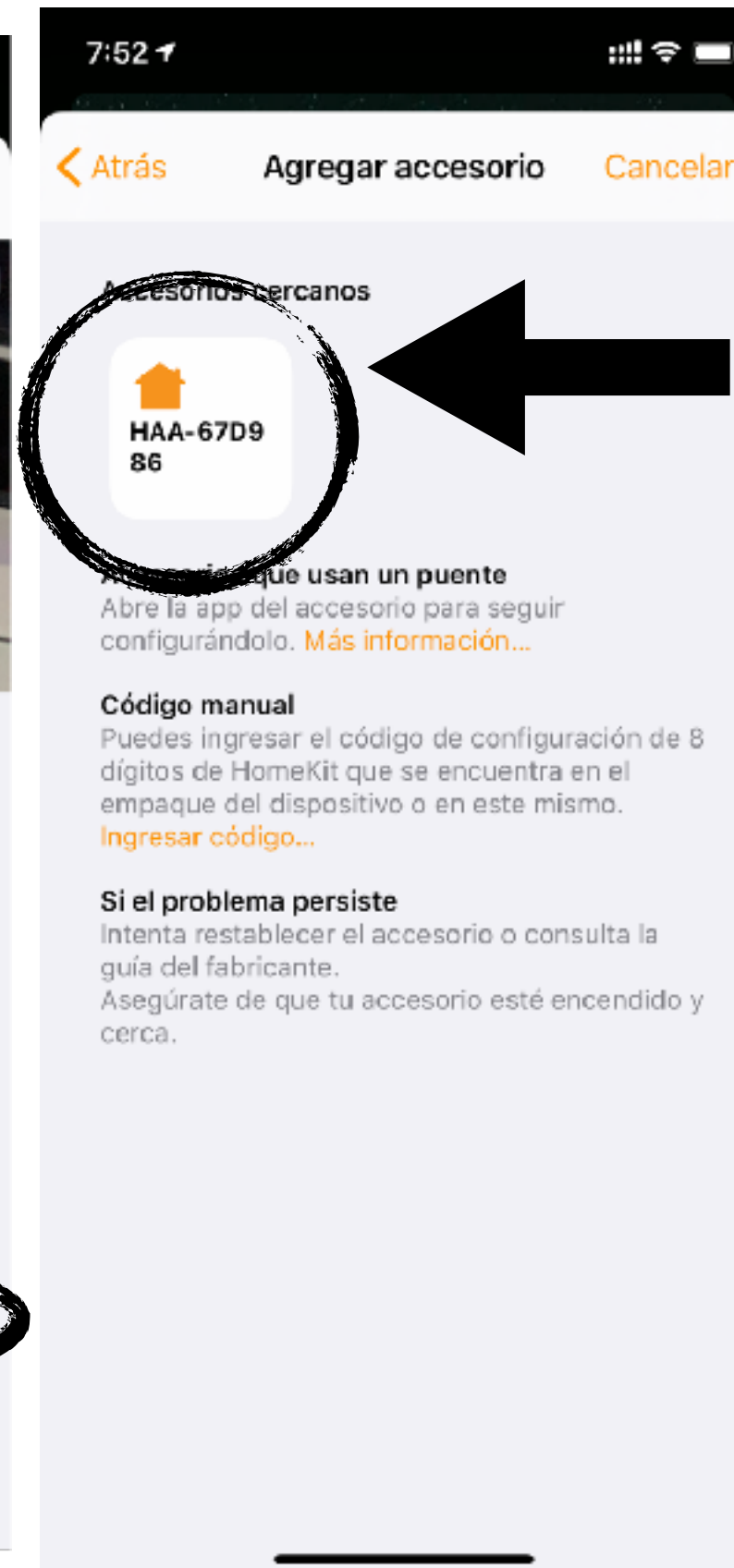

Selecciona "Tu accesorio"

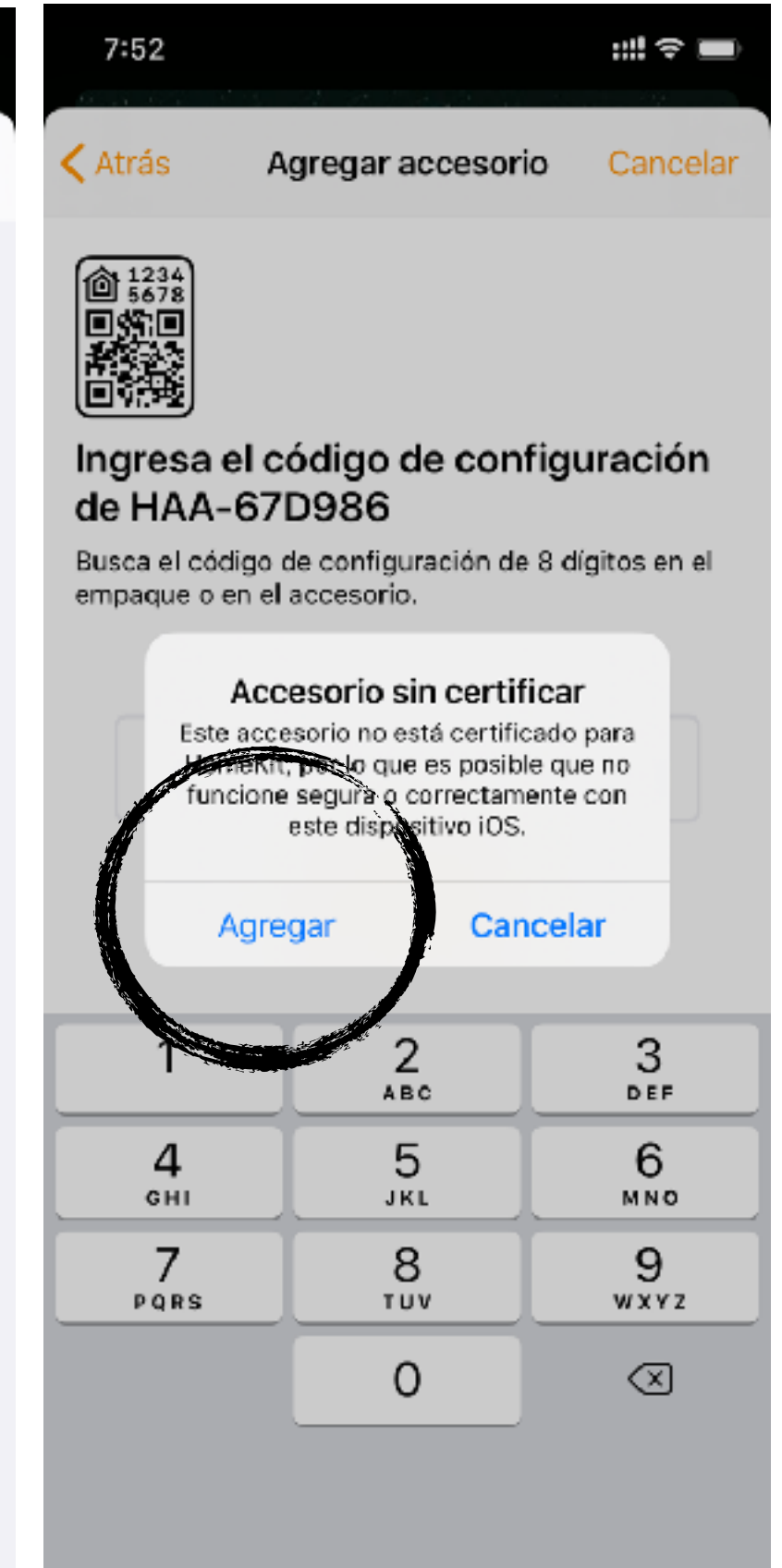

Selecciona "agregar"



podrás agregarlo de 2 formas

1.- poniendo el código manual mente



2.- escaneando con la cámara



# LISTO!!

a disfrutar de tu accesorio

## Soporte:

Lunes-Viernes 10:00 a.m a 6:00 P.m.  
Sabados 11:00 a.m a 3:00 P.m.



Tel: 5543421047

# iShop Homekit

# Reset del apagador

Si por alguna Ocasión cambias de modem de internet o bien quieres restablecer el dispositivo tendrás que apagar Y prender 10 veces seguidas de manera rápida para entrar de nuevo a la red wifi sonoff#####

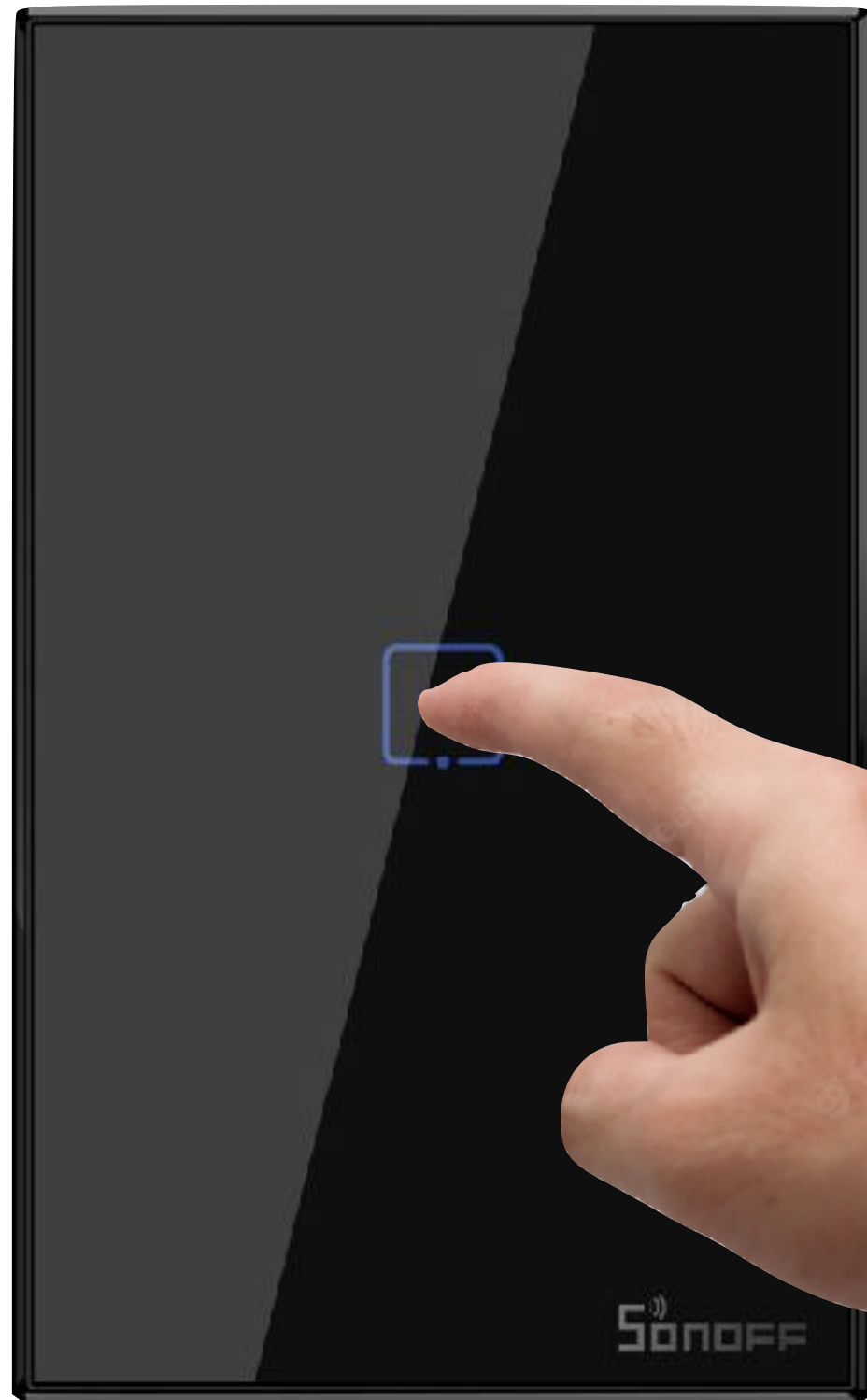

Opción de restablecimiento de dispositivo  
Marca las casillas de:  
Reset homekit  
Reset Wifi settings



WiFi SSID (RSSI Channel)	BSSID
Totalplay-2CA2 (-88 Ch10)	c4447d014a60
IZZI-E854 (-87 Ch6)	803f5d774762
Z1 (-70 Ch8)	d463fec3f0af
INFINITUM77A4_2.4 (-90 Ch7)	f4b78d0257c0
(-54 Ch2)	1c3bf3c90c46
(-50 Ch2)	1c3bf3c91b02
(-60 Ch2)	84d81b3c0f26
(-59 Ch2)	84d81b3c0fae